

SPLIT-FIRE®

Owners Manual 4003 3 PT Wood Chipper



*Thank You for Purchasing a Split-fire 4003
Woodchipper!*

*We appreciate having you as our customer and wish you many
years of safe and satisfactory operation with your machine.*

SPLIT-FIRE SALES INC.

285633 Airport Road
Norwich, ON N0J 1P0
Canada

1-877-548-3473 / 519-468-3647



Please share a google review about your
Split-Fire experience

Contents

- 1. Introduction 4
 - 1.1 How to use your Owner’s Manual 4
 - 1.2 Product Identification 6
 - 1.3 Warranty 8
- 2. Safety 9
 - 2.1 Safety Labels 9
 - 2.2 Wood Handling Safety 16
 - 2.3 Operation Safety 17
 - 2.4 Worksite Safety 19
 - 2.5 Option Safety / Operation 20
 - 2.51 Rear Hitch 20
- 3. Chipping Capacity 21
- 4. Operation 22
 - 4.1 Before Operation 22
 - 4.2 Three Point Hitch Chipper Setup 24
 - 4.21 Emergency Stop Configuration 27
 - 4.22 Infeed and Outfeed Clcking 29
 - 4.3 After Operation 30
 - 4.4 Operation Troubleshooting 31
- 5. Maintenance 33
 - 5.1 Woodchipper Maintenance 33
 - 5.11 Blades / Rotor Maintenance 33
 - 5.12 Rotor Maintenance 34
 - 5.13 Anvil Maintenance 35
 - 5.14 Bearing Maintenance 35
 - 5.15 Gearbox Maintenance 36
 - 5.16 PTO Shaft Maintenance 36
 - 5.17 Belt Maintenance 36
 - 5.18 Latch Maintenance 39
 - 5.19 Torque Spec Chart 39
- 6. Storing Your Woodchipper 40
- 7. Checklists 41
 - Safe Feeding Checklist 42
 - Machine Operator Safety Instructions 43
 - Parts Breakdown 46

1. Introduction

1.1 How to use your Owner's Manual

This owner's manual is a very important part of your new machine and should remain a permanent part of it. If the machine is sold, the operator's manual must go with it.

By reading the operator's manual you will help yourself and others avoid unnecessary personal injury and/or damage to the machine and will also allow you to perform maintenance to keep your machine operating properly. The information recorded in this manual will help you use this machine safely and effectively. Once you know how to operate the machine correctly and safely, you can train others to operate the machine as well.

If your machine has been ordered with any options or attachments, please refer to the option safety section of the individual operator's manual that is included with that specific accessory.

The machine that is used in this manual for illustration may differ slightly from your model. It will be similar enough to help you understand our instructions.

Throughout this manual the terms "Left Hand" and "Right Hand" will be used. These sides are determined when standing in front of the 3-Point Hitch pickup, as if you are the tractor. The "Information Plate" side of the chipper is the right side. Also "Back" and "Front" will be used. On the 4003 woodchipper the "Front" refers to the 3PT Hitch pickup location. So, the information plate would be located on the front right of the 4003 woodchipper.

Your machine has been tested and inspected to pass quality control at Split-fire's Manufacturing facility to ensure good performance prior to leaving the factory.

While reading the manual, important messages are used to bring the operator's attention where there may be safety concerns relating to machine damage and important servicing information. Please read all these messages to avoid personal injury and machine damage. The three main messages will start with:

WARNING!!! which suggests, a strong chance of personal injury or death to the operator or bystanders if procedures are ignored.

IMPORTANT: which suggests, a strong chance of potential damage to the machine may occur if procedures are ignored.

NOTE: suggests to the operator, General information given to help the operator to operate or service the machine.

1.2 Product Identification

If you ever need to contact your dealer or the manufacturer for parts or questions regarding the operation or servicing of the machine, it is important to have the model number as well as all the necessary identification numbers. Using the sample pictures on page 7 you can find the necessary numbers to complete the spaces below.

Date of Purchase:

Dealer Name:

Dealer Phone Number:

Frame Serial Number: (XX XX XX)

Frame Serial Number



1.3 Warranty

Split-Fire Sales Inc. guarantees the original purchaser of any new Split-Fire machine, that the same is free of defects in workmanship or materials that may cause performance failure, subject to the condition's hereafter.

Split-fire must be contacted before the problem on the machine has been fixed. Split-fire will diagnose the problem and authorize any warranty work that will be allowed. If Split-fire does not authorize or parts are not sent from Split-Fire, warranty will not be applicable.

This guarantee is limited to a period of one year from the date of purchase. Replacement of any defective part is free of charge FOB Split-Fire Sales Inc. If Split-Fire requires the parts to be returned to Split-Fire, Split-Fire will pay for return shipping.

This guarantee does not apply to engines or other parts that are manufactured and guaranteed by the manufacturer thereof, nor does this apply with respect to any part or product that:

1. has original parts removed or otherwise altered without specific authorization beforehand from Split-Fire Sales Inc.
2. has had placed upon or attached to it, any part or product not sold or approved by Split-Fire Sales Inc.
3. has been damaged or is not used in conformity with the applicable instruction for the machine.
4. has not been properly adjusted or maintained by the owner.
5. has been adjusted or altered to increase the performance of the machine.

This guarantee is in lieu of, and excluded all other guarantees and conditions of merchantability and fitness for a purpose. Acceptance of a Split-Fire Sales product constitutes an agreement that Split-fire Sales shall have no liability for any special or consequential damage.

2. Safety

2.1 Safety Labels

The machine safety labels shown in the section below are very important. They are placed in areas on the machine that draw the attention of the operator to potential safety hazards on the machine. If at any time the stickers are removed, or come off, contact your dealer or the manufacturer immediately for replacement decals.

The operator's manual explains the potential safety hazards in detail associated to each decal. Special attention should be kept for these recommendations. They are outlined for your safety.



The Emergency Stop switch is a safety system that is in an easy access point to stop the woodchipper in case of an emergency. The emergency switch is situated at the top of the 3-point hitch pick-up for easy access. When connected as outlined later in the manual this switch will stop your tractor's engine, and in turn the chipper.



This sticker is located in the infeed chute. Do not remove or modify safety guards on this machine or serious injury or death may occur. Safety guards have been put in place for safe operation and must not be removed at any time during operation.

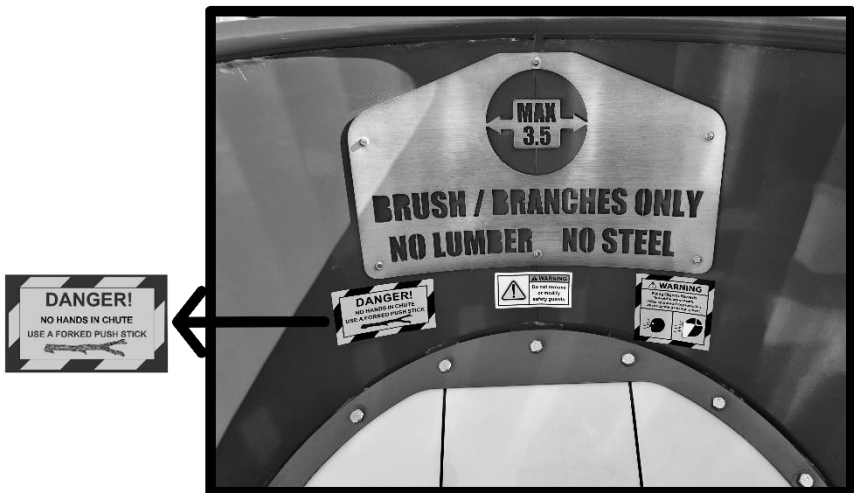

This sticker is located in the infeed chute. Do not put hands, arms, feet, legs or any body part in the infeed chute. If material needs to be pushed down to engage the chipping blades use a forked push stick. This will allow you to push the material into the blades without risk of injury or harm.



This sticker is located in the infeed chute. It states the requirement of eye protection, and a full-face shield is recommended. Wood flyouts may occur and the correct PPE will ensure that the operator is safe.

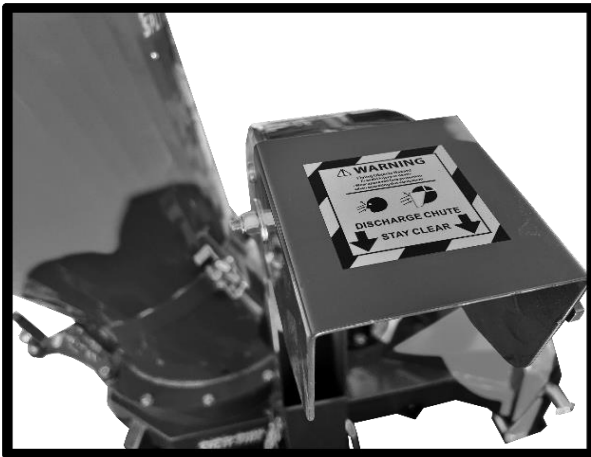

This sticker is located on the chip deflector on the back of the machine. When chipping wood, chips will be discharged out of the discharge chute at high rate of speed. Angle the discharge chute toward the ground to control the chips, and do not walk through the stream of chips while operating the machine.

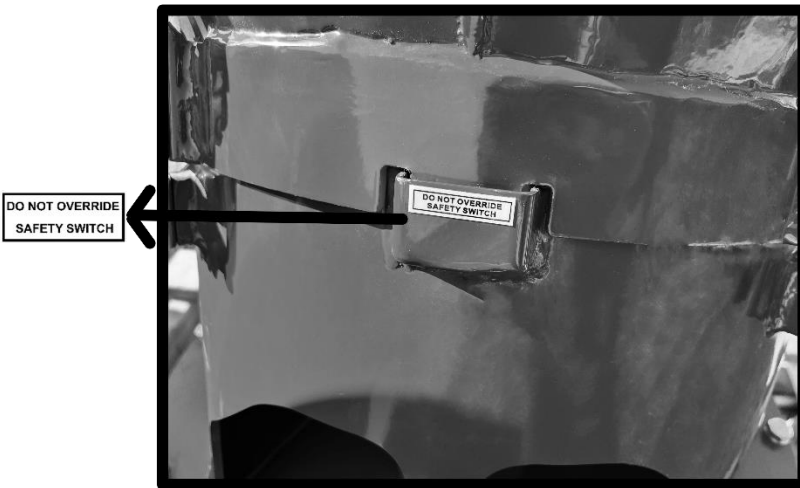

This sticker is located on the safety switch on the lower infeed chute. Safety switches have been located in areas to maintain safe operation. Do not tamper, modify or remove any safety switches on this chipper.



This sticker is located behind the infeed chute latches. When operating the machine, only remove the infeed chute after the emergency stop has been actuated, the engine is switched off, and after both the engine and the chipping rotor have come to a full stop.

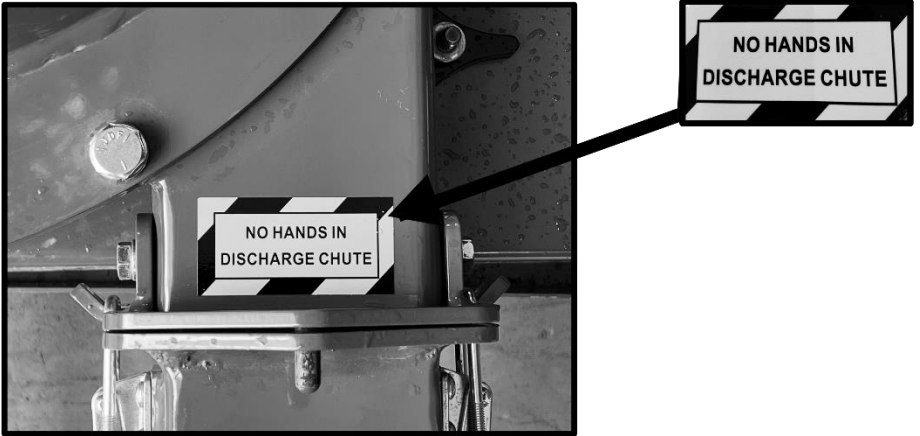

This sticker is located on the discharge chute. When operating the machine, at no time put hands or any body part into discharge chute. If hands or any body part are inserted into the discharge chute during operation, serious injury or death may occur. If the woodchipper is jammed, the woodchipper must have come to a complete stop, the emergency stop must be activated (down) and the tractor must be switched off. Then any debris in the discharge chute can be removed safely.



This sticker is located on the back of the infeed chute. This sticker is a visual pre-run checklist for operators to study before they operate the machine. Even after reading the owners manual, this pre-run checklist must be read to ensure the operator is wearing proper PPE and understands safe operation.

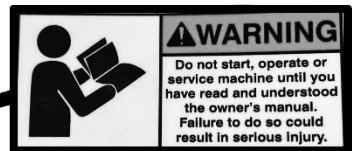

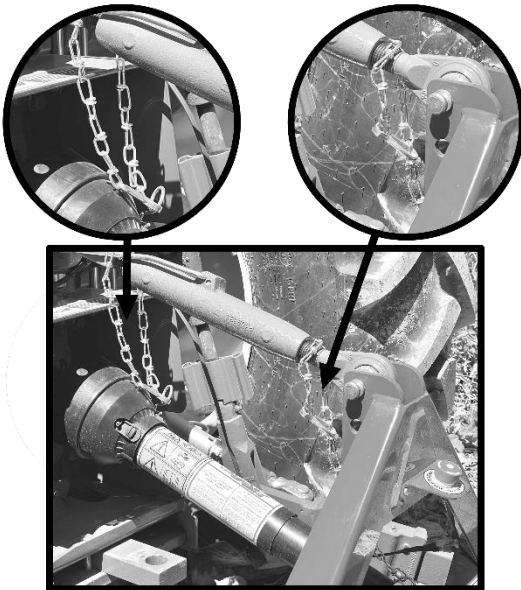

This chipper uses a PTO Shaft. It is important to always follow PTO shaft guidelines. Always verify that the PTO shaft is in good operating condition, with the applicable plastic safety shroud. Always ensure that the safety shroud is fastened appropriately via the 2 attachment chains. If the PTO shaft is not in proper operating condition, the chipper must not be used.

It is important to always be careful when working around a PTO Shaft as entanglement can cause serious injury or death. Never remove guarding. Never operate above 540 RPM

2.2 Wood Handling Safety

It is important that the operator understand wood safety when operating a woodchipper. A general understanding of wood chipping practices will make the operation easier and safer.

When cutting trees and tree limbs always use the appropriate PPE and correct tools. If the tree is large, get help to make the job easier and safer. Stack the branches and sticks in an organized pile away from muddy patches. Muddy branches and sticks could have dirt, gravel and other foreign material stuck to them which could damage the woodchipper. Always give the branches and sticks a quick visual inspection before feeding into the chipper. Foreign material will damage the woodchipper and could cause serious injury or death.

This 4003 chipper has been designed for a max capacity of 4" diameter. If branches are larger than 4" diameter, utilize the oversize sections as firewood. If the branches are 4" diameter and under, cut the branches as follows:

- ✓ Cut to a manageable length of no more than 6' long.
- ✓ If branches are twisted and curvy, it may be beneficial to cut the branches into shorter lengths for ease of transportation and feeding.
- ✓ If the branches have large Y sections, these may need to be trimmed to enable them to be fed into the chipper. Keep in mind, any branches with a Y can be utilized as forked push sticks to feed tough and stubborn material into the infeed chute.
- ✓ A large armload of small sticks and leaves can be loaded into the infeed chute. This type of material may need to be pushed in with a forked push stick.
- x Do not load branches with mud, dirt, nails, spikes, or foreign material. This will cause damage to woodchipper and could cause injury or death.

Safe operation with clean branches and sticks will allow for safe and effective operation of the machine.

2.3 Operation Safety

Carefully read and understand all the instructions pertaining to the woodchipper in the operator's manual before operating your new machine. Anyone who operates or services this machine must read the owner's manual first. If any doubt or question arises about the safe and/or correct method of performing anything in this manual, contact our representatives at the Split-Fire head office.

Avoid accidents by being alert and recognizing potential hazards. Not all possible circumstances can be anticipated in this manual. Keep your woodchipper and work area safe for yourself and others. Proper PPE , care and safety are your responsibility.

NOTE! This 4003 chipper must never be used indoors or in a unventilated area. Your tractor's engine will produce harmful carbon monoxide that can seriously injure or kill.

- x Never allow untrained persons to operate or service this woodchipper.
- x Never let persons under the age of 18 operate this woodchipper.
- ✓ The owner is responsible for accidents and injuries to themselves and/or other persons operating their machine. If others are permitted to use this machine it is the responsibility of the owner to train and supervise users.
- ✓ New users may operate this machine in a clear, unobstructed area under the supervision of an experienced operator, only after they have read and understand the owner's manual.
- ✓ Only allow responsible adults who have read the owner's manual and are familiar with the controls to operate the woodchipper.
- ✓ Inspect your machine each time before use. Special attention should be taken that all components are in place, damaged or missing parts are replaced, and that all the safety decals

Safety

- ✓ highlighted in the safety labels section are in place and visible on the machine.
- ✓ Only one person may operate the machine at any time. More than one operator greatly increases the chance of personal injury or death.
- x Never leave machine unattended while running.
- x Never operate the machine when under the influence of alcohol or drugs.
- x Do not alter, add accessories, or attachments to your woodchipper without the approval of the manufacturer. Doing so without the manufacturer's approval WILL VOID THE WARRANTY. If attachments have been added with approval of the manufacturer, be sure to keep safety labels visible.
- ✓ Your machine is designed to chip wood only! Stones, metal, gravel, and other foreign objects will cause damage to the machine and will increase the chance of personal injury or death.
- ✓ Always wear proper PPE before working on the worksite and before starting and operating your 4003 woodchipper. Proper PPE must include, but not limited to – Eye Protection, Ear Protection, Foot Protection, Hand Protection.

2.4 Worksite Safety

Worksite safety is very important for operator safety. A clean organized worksite will allow the operator to work safely and effectively.

- ✓ Keep area around the woodchipper clear from tall grass, debris, tools, and large pieces of wood at all times.
- ✓ Operate woodchipper on a dry level surface only.
- x Do not operate machine when distracted by others. Keep children and pets at least 50 feet away from the work area to protect them from possible injuries. Keep other distractions such as electronic devices, cell phones, etc. away.
- ✓ Only use machine during daylight hours. Use of this machine without proper lighting can lead to personal injury or death.
- ✓ Protect yourself at all times while operating your machine. Safety glasses, a wood working face mask, hand protection, steel-toed boots and ear protection must be worn at all times.
- ✓ The operator must wear fitted clothing at all time. Loose clothing can increase the risk of injury or possible death.
- x Do not transport this machine while the PTO is engaged. This may cause permanent damage to your woodchipper.
- ✓ Always disconnect the PTO shaft when the woodchipper is being serviced.

Safety

2.5 Option Safety / Operation

2.51 Rear Hitch

The rear hitch is an option that allows the user to tow a utility trailer behind the woodchipper. This option is for off-road use only!! If installation is not completed by a Split-Fire technician, follow the instruction manual associated with the option.

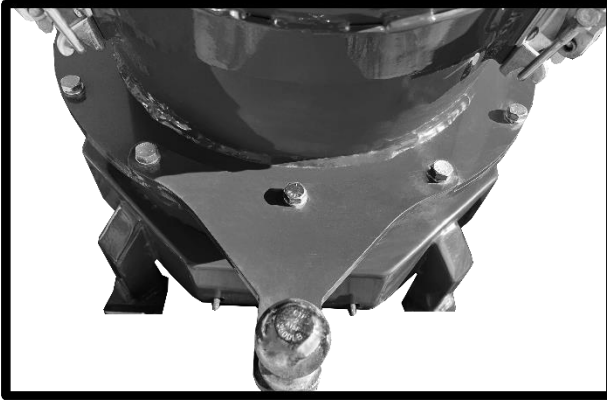

Rear Hitch Safety

- Do NOT use for on-road use
- Do NOT tow machinery / trailers faster than 40 km/h
- Do NOT tow machinery / trailers with a tongue weight over 200 lbs.
- Do NOT tow machinery / trailers with a gross weight over 800 lbs.

Rear Hitch Operation

The rear hitch is a static option that allows the user to tow machinery / trailers behind the woodchipper. This option is for off-road use only!! The rear hitch option does not affect woodchipper operation in any way. The rear hitch option has a max tongue weight capacity of 160 lbs. It is important that when chipping, the machinery / trailer be either turned away from the discharge chute or unhooked from the woodchipper for both operator safety and damage prevention. The rear hitch can either be used as a farm style hitch or can be fitted with a 2" ball for ease of use with any utility trailer.

3. Chipping Capacity

This 4003 chipper has been designed to chip brush and branches up to 4" in diameter. Brush and branches must be cut to the appropriate length to ensure the chipper processes the material properly. Brush and branch material will vary due to the ambient temperature, type of wood, moisture content, and the age of material since felling.

Overloading the will cause premature blade and belt wear and in certain cases, bearing damage can occur. The shear pin in the PTO shaft will break to prevent geartrain failure and further damage, be sure to inspect before each use to ensure this failsafe is in place.

Cut the following size branches to the following lengths to ensure chipper operation, and operator safety:

1. 2" Branches / Brush = 12 Feet. This diameter can be easily chipped without loss of rotor inertia. Keep branches and brush under 16 foot for ease of mobility and safe loading.
2. 3" Branches / Brush = 6 Feet. This diameter takes medium power and will cause the rotor to lose inertia when chipping lengths over 6 feet. Keep 3" diameter branches and brush under 6 feet for operator mobility and safety when loading.
3. 4" Branches / Brush = 3 Feet. This diameter takes maximum power and will cause the rotor to lose inertia when chipping lengths over 4 feet. Keep 4" diameter branches and brush under 4 feet for operator mobility and safety when loading.

When chipping any branches / brush, the operator must be constantly vigilant of the chipping operation. If the operator notices the chipper losing rotor inertia, the material must be removed so the tractor/ chipper can regain RPM's and rotor inertia. Full instructions can be found on page 24 (Operation)

4. Operation

4.1 Before Operation

Before operating your machine, inspect it to ensure it is in good, safe working order.

1. It is important that you have read and understand all safety requirements before operating the 4003 woodchipper. Read both the 4003 woodchipper, and tractor's owner's manual before operating the machine.
2. Verify that the blades are in good operating condition. This can be checked by removing the infeed chute via the 4 latches and checking that the blades are sharp and tight. If the blades are dull or have nicks and dents in them exceeding 1/16" the blades must be turned to a fresh side or replaced. If the blades are loose or being replaced, they must be retorqued to 35 ft/lbs. For full blade change instructions, see details on page 33.

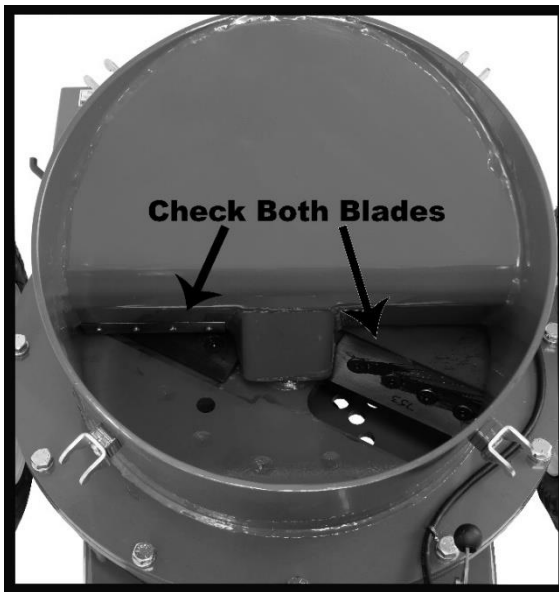

3. Be sure that the infeed chute is securely attached via the 4 latches. The 4 latches must be in the locked position. If the latches are not tight, see full latch maintenance details on page 38.
4. Check that the kickback guard in the infeed chute is in good condition and operating properly. If the guard is broken or missing sections, do not operate the woodchipper. New parts can be ordered by calling Split-Fire's parts department.
5. If connected, check that the Emergency switch is functioning properly. When pressed down, the emergency stop should click and remain in the depressed position. To reset the emergency stop switch, twist clockwise and pull lightly. The emergency stop button should click and spring up to the run position. If the emergency stop button is connected and does not operate properly do not run the machine. The emergency stop must be replaced and working properly before operation begins. See page 27 for information on E-Stop connection and use.
6. Clean the worksite around the chipper. Make sure there are no trip hazards, branches are in organized piles, and that the woodchipper is on level ground.
7. Put on the required PPE. Safety glasses / face shield, ear, hand, and foot protection are all required when operating this 4003 woodchipper.
8. Once the "before operation inspection" is completed, the woodchipper is ready for operation.

4.2 Three Point Hitch Chipper Setup

1. Reverse tractor to 3 PT Chipper.
2. Lower 3PT hitch arms to correct connection height.
3. Unlock lower tractor 3PT hitch arms.
4. Reverse tractor so lower 3 PT arms are close to chipper pin.
5. Slide right lower 3 PT Hitch arm over connection pin on chipper.
6. Secure 1st connection with lynch pin.
7. Slide left lower 3 PT Hitch arm over connection pin on chipper.
8. Secure 2nd connection with lynch pin.
9. Lubricate PTO stud on tractor with some light oil (WD40).
10. Pull back retaining collar on PTO shaft, and slide PTO shaft onto Tractor PTO Stud.
11. Release PTO locking collar and verify that the PTO shaft is locked into position.
12. Tighten and attach both PTO chains to the holes located at the 3PT hitch Frame / Top link (This will ensure that the PTO shaft is safe and operating properly).
13. Attach top link to woodchipper by lowering it and inserting pin.
14. Adjustment of top link may be needed by turning top link in or out to make the chipper sit level to the ground.
15. If being used, connect the E-Stop to the tractor, for E-Stop installation instructions see page 27.
16. Woodchipper is now connected and can be lifted off the ground.
17. The woodchipper can be moved to the chipping site.

18. Proper protective gear must be worn (Safety Glasses, Ear Protection, Gloves).
19. The tractor must have its parking break engaged.
20. The tractor can be slowed to just above an idle.
21. The chipper must be set on the ground (Level ground only)
22. The PTO can be engaged (Engage PTO shaft very slowly or tractor will stall. Do not increase RPM's and then engage PTO as this could harm the PTO clutch in your tractor).
- IMPORTANT:** If the tractor stalls multiple times, and the chipper rotor does not start rotating check for jams before increasing RPM to avoid damage to the chipper or tractor.
23. Once the PTO has been engaged and the chipper is operating and spinning, increase RPM's to a full 540 PTO RPM.
24. Start chipping small branches first, then chip large branches once operator confidence has increased.
25. Start chipping with small branches first. If any abnormal noises are heard, immediately shut down the woodchipper by pressing the emergency stop (if connected), or disengaging the PTO.
26. If the woodchipper is chipping the branches quickly and easily, chipping can continue with large branches.
27. When chipping larger branches be aware of engine and rotor RPM. If a large hardwood branch is being loaded, be aware that the chipper may slow down and ultimately stop from lack of input power. If the chipper stops under engine load, it could damage the belt or break a PTO shaft shear pin. When a larger branch is being feed, pay close attention to engine and rotor RPMs. If the RPMs slow, pull back the branch to allow the woodchipper to recover RPMs. Once the woodchipper is operating at full RPMs, the rest of the branch can be fed into the infeed chute.

Do not attempt to pull back branches that are beyond the lip of the infeed chute. Branches this far into the chipping cycle will feed through as the amount of wood remaining is manageable.

28. Continue chipping as needed. Always be vigilant of your surroundings on the worksite and on the material being fed into the 4003 woodchipper.

If any abnormal noises or movements are observed, stop the woodchipper immediately by pushing the emergency stop switch (if connected) or by disengaging the PTO. Contact Split-Fire immediately concerning the issue.

Once chipping has been completed, follow these shutdown steps:

1. Allow the woodchipper to run under no load for 1-2 mins. During that time verify that the infeed chute is totally empty. If there are any remnants, use a forked push stick to clear the infeed chute. This will allow the woodchipper to clean itself out and run under no load.
2. Once the chipper has been cleared out, the PTO lever can be disengaged.
3. RPM's can be lowered
4. The woodchipper can be moved back to its storage location and removed from the tractor.

4.21 Emergency Stop Configuration

This 4003 woodchipper is equipped with an emergency stop circuit that can be wired into your tractors seat switch to allow the user to stop the chipper in an emergency situation without having to access the tractors controls. This can be wired either to the seat pressure switch circuit or the PTO Seat Up switch circuit.

The seat pressure switch senses a person sitting on the tractor and turns off the engine when the driver gets off of the tractor for safety reasons. Wiring the chipper emergency switch to the seat pressure switch circuit bypasses the seat switch when the chipper is connected. This is safe to operate as the circuit will not allow the tractor to start if the seat switch and chipper are both disconnected, one of them must be connected for the tractor to operate.

The seat up switch is the better circuit to connect the chipper to as in some cases there is a delay built into the seat pressure circuit which will cut down on the effectiveness of the emergency stop. This circuit may not be present in all tractors, but if equipped we suggest using this circuit. When the chipper is connected, and the E-Stop button is in the up position the seat pressure switch will not work.

Warning!!!: Do Not connect the E-Stop circuit to your tractor unless you are using this woodchipper. If the woodchipper is not in use always reconnect the seat switch. This could lead to personal injury or death.

1. Locate your tractors seat pressure switch wiring, or PTO seat up switch wiring if your tractor is equipped with this option. This information can be found in the tractor owners manual, or by calling the dealer where your tractor was purchased. The switch will have two wires coming from it, these are the ones needed for this installation.
2. Ensure that the tractor is turned off before doing any work.

Operating Instructions

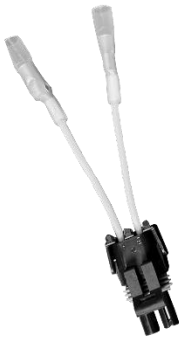

To Seat Switch



To Chipper



To Tractor

3. Cut and strip approx. 3/8" of sheathing off of the two wires that are connected to the seat pressure or seat up switch, and the two wires on the tractor side.
4. Crimp the supplied female plug to the two wires on the tractor side of the cut wires, and use a torch or heat gun to shrink the crimp coating.
5. Repeat step 4 using the male plug, connecting it to the seat switch side of the cut wires.
6. Check the connections just made by connecting the two plugs just added and starting the tractor. You will need to be sitting in the seat for it to work as the seat switch is connected when these plugs are connected.

7. You can now disconnect the seat switch and connect the male plug just added to the tractor to the female plug on the chipper, ensure that the E-Stop Button is in the up position, and the infeed chute is in place and latched. The tractor will now be able to start without you present on the tractor.

NOTE: If the tractor does not start after connecting the woodchipper, with the E-Stop button up and the infeed chute in place, please contact Split-Fire head office as alternative E-Stop and infeed chute switches may be required.

4.22 Infeed and Outfeed Clocking

The chipper box and top cap / infeed chute on the 4003 can be clocked / rotated to place the infeed and outfeed chutes in the best orientation for your specific use case.

Instructions on how to clock the orientation can be found on our YouTube channel at "<https://www.youtube.com/c/SplitFireSalesInc>".

4.3 After Operation

After chipping has been completed, after operation procedures must be completed for safety and machine maintenance.

1. Once the woodchipper has completely stopped and cooled off, remove any small debris on the exterior of the machine.
2. The woodchipper should be cleaned after every use. This can be done with a water hose, pressure washer, or high-pressure air. All the debris must be removed, including any leaves / debris around the lower guard air vents.
3. Give the woodchipper a visual inspection. Check for loose fasteners, latches, oil leaks, etc. and repair as needed. It is important the woodchipper be in an excellent mechanical state for safe and effective operations.
4. Regular maintenance must be completed before the next wood chipping operation. See maintenance schedule on page 33.
5. Store the woodchipper in a secure, clean dry location if possible. This will reduce the risk of theft, corrosion and damage. See storage details on page 40.

After chipping it is important to clean and maintain your 4003 woodchipper. This will properly prepare the machine for its next use.

4.4 Operation Troubleshooting

1. The woodchipper has jammed, and the belts smoke when the PTO is engaged, or the tractor stalls when engaging the PTO at approx. 135 RPM PTO Speed.

This is occurring because the chipper has been overloaded with too much wood and the result is a jam. The excess wood must be removed from the woodchipper. Ensure that the PTO is disengaged, and the emergency stop is in the off (down) position (if connected). The tractor must be shut off and not operating. Then remove the infeed chute and remove / pull any excess wood from the chipping blade area. Also ensure that the discharge chute is empty of chips / debris. The rotor must be able to spin freely by hand. If it is stuck / jammed, a large stick can be used as leverage against a blade to spin the rotor counter clockwise. Once the rotor is spinning freely, place the infeed chute on the chipper and securely fasten it with the 4 clamps. Operation can then resume.

Do NOT attempt to use hands/feet for leverage. The chipping blades are sharp and will cause personal injury or death.

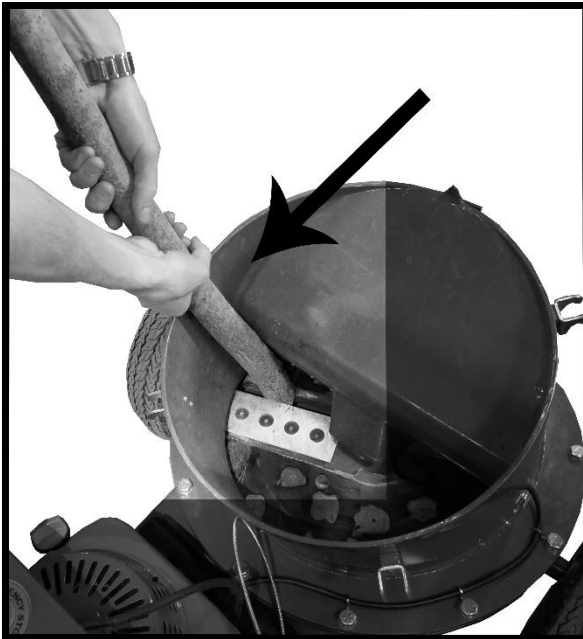

2. The woodchipper is chipping wood, but it gets jammed quickly and the RPM's slow down easily.

This is occurring because the blades on the chipper could be dull. When the chipping blades are dull, the machine is not as efficient. The tractor will need to work harder to chip even small material. This can be fixed by completing blade maintenance. The blades need to either be flipped to a fresh side or replaced with new blades. See blade maintenance on page 33.

3. The woodchipper is chipping wood, but the wood does not self-feed and needs to be pushed into the infeed hopper for any chipping action to occur.

This is occurring because the blades on the chipper could be dull. When the chipping blades are dull, the machine is not as efficient, and the branches / sticks will not self-feed. As the blades begin to dull, the chipping action will become less efficient and the branches / sticks will not self-feed. This can be fixed by completing blade maintenance. The blades need to either be flipped to a fresh side or replaced with new blades. Once the blades have been replaced, the chipped will self-feed the branches / sticks with ease. See blade maintenance on page 33.

6. The woodchipper slows / bogs down when large branches are being chipped.

This is normal for large branches in the 3.5" – 4" range. If a large branch is to be chipped. It is important that the operator be ready to pull back the branch once the chipper RPM's slow to below 50% RPM. Once the large branch has been inserted, the chipping blade will grab the branch to self-feed. Due to the branches size and strength, the woodchipper will lose rotor inertia and will start to slow down. As the rotor slows down, the operator must pull the large branch back to allow the woodchipper to recover RPM's. It is important that the operator NOT attempt to put his/her hands in the infeed chute to pull back large branches. Once the large branch has passed the infeed chute rim, the branch must be left alone.

5. The woodchipper belts are smoking / slipping.

Verify that the woodchipper is not jammed. If the woodchipper rotor is spinning during operation, but the belts are still smoking / slipping when operating, the belts need to be replaced. The belts on this chipper will wear over time and must be replaced.

Please refer to the instructions on page 36 to check tension and if needed replace the belts.

6. The woodchipper came to a sudden and abrupt stop and wont start moving again even with the PTO Engaged.

This means that there has been a jam caused by accidentally loading foreign material such as stones or metal into the chipper. This has likely caused the shear pin to break to keep the gearbox on the chipper and the gearbox and clutch on the tractor safe. The shear pin is located on the chipper end of the PTO Shaft between the joint and connector on the chipper gearbox. If the shear pin is broken or missing check the chipper box for debris and dislodge anything jammed in the rotor. Once cleaned the rotor should spin freely. If the rotor does not spin freely, the shear pin is not broken, or a new shear pin is required, please call Split-Fire head office.

5. Maintenance

Maintaining your 4003 woodchipper is very important and will ensure that the machine lasts year after year offering safe, smooth and reliable operation.

5.1 Woodchipper Maintenance

5.11 Blades / Rotor Maintenance

Your woodchipper will have 2 blades. Blades are a consumable item that will need to be sharpened or replaced when they get dull.

Woodchipper blades can be sharpened 2-4 times depending on the depth of each sharpen. These woodchipper blades are case hardened and must be sharpened at the same angle, but not be sharpened further than .125" from the original edge. Both blades must be sharpened equal amounts to maintain blade balancing.

When removing the blade use a $\frac{3}{4}$ " locking pin to keep the rotor from spinning. Use a $\frac{1}{4}$ " hex key to remove the 4 bolts per blade. It is important to ensure that the hex pattern in the bolt head is clean, so the hex key sits fully in the bolt to prevent stripping the bolt head. Once the blades have been removed, they can either be flipped to a sharp side or replaced with a new blade.

When installing blade(s) it is very important to follow the proper steps. Anti-seize (silver grade or nickel grade) paste must be applied to the bolt threads and head. The rotor and blade surface must be clean and dent free. Then the 4 bolts per blade can be threaded in, hand tight. With the $\frac{3}{4}$ " rotor locking pin in place, the blade(s) can be tightened with a torque wrench to 35 ft-lbs. All 4 bolts per blade must be torqued to 35 ft-lbs. (Only use an accurate torque wrench). Once the blade(s) have been torqued, they are ready for operation.

WARNING!!! All chipper blade bolts and anvil bolts must be replaced every four torquing cycles, Failure to do so could cause harm to the woodchipper or injury or death to the operator.

5.12 Rotor Maintenance

Your woodchipper rotor will not need specific general maintenance, but when changing blades and maintaining your machine it is important to inspect the rotor to ensure that it is in good operating condition.

When changing blades, always inspect your rotor for defects. This can be done by slowly rotating the rotor by hand and inspecting for cracks and defects. Furthermore, when changing blades, ensure that the rotor blade surface is smooth, and the threads are clean and in good working condition. If any cracks or defects are observed, call Split-Fire service immediately. Do not operate the machine if defects are observed.

5.13 Anvil Maintenance

Your woodchipper anvil will need to be maintained on a regular basis. Every time the woodchipper blades are switched, the anvil must be inspected and reset to ensure proper anvil / blade spacing. It is important that the anvil is always set within .020" - .040" of the chipping blade. This will allow the woodchipper to chip the wood easily and will also extend blade life. After the blades have been replaced and are properly installed the anvil can be set. First loosen the 4 anvil bolts. Keep the 4 bolts snug so the anvil blade is not loose but can be moved with some force. Turn the rotor / blade to the anvil. Then adjust the anvil to a position of .020" - .040" above the tip of the cutting blade. Move the rotor back and forth and adjust the anvil blade as necessary. After the anvil blade has been set, turn the rotor to check the clearance on the second blade. Both blades should be equal distance, but if variance is observed, set the anvil to the tallest blade. After the anvil has been properly adjusted, the 4 anvil bolts can be torqued to 45 ft-lbs. (Only use an accurate torque wrench). Once the anvil has been torqued, the woodchipper is ready for operation.

5.14 Bearing Maintenance

Your woodchipper has two main rotor bearings. These rotor bearings enable the rotor to spin smoothly at a high rpm. These bearings must be maintained. The upper and lower bearings need to be greased with 2 pumps every 50 hours. Do not over grease the bearings. Over greasing will cause the bearing seals to lose effectiveness and will ultimately ruin the bearing.



Maintenance

5.15 Gearbox Maintenance

Your woodchipper utilizes a gearbox to transfer PTO power to the pulley system and then to the rotor. The oil in the gearbox should be changed after the first 50 hours or first year, then every 2 years after that using 80w90 gear oil. Fill the oil through the fill port with the fill check port fitting removed, fill until oil starts coming out of the hole, then replace both the fill check port, and fill port fittings.

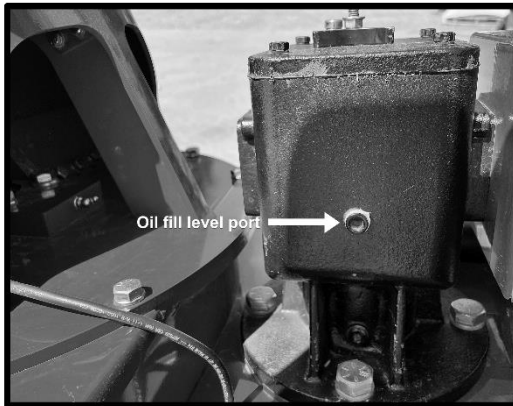

5.16 PTO Shaft Maintenance

Your wood chipper is connected to your tractor using a PTO Shaft equipped with a shear pin to protect the chipper and tractor from an overload should a piece of metal or stone accidentally enter the chipping box causing the chipper to come to an immediate halt. This pin should be checked to ensure that the nut is not backed off, loss of this shear bolt will mean loss of power to the chipper. The two universal joints should be greased with 2 pumps of grease every 50 hours to ensure a long life.

5.17 Belt Maintenance

Your woodchipper utilizes a pair of B belts to transfer PTO power from the gearbox to the rotor. These belts are a consumable and will wear over time. The belts should be inspected every 10 hours of operation. During operation, a jam may occur. This can cause the pulley to slip on the belts causing a wear spot. If a jam occurs for more than 20 seconds, the belt must immediately be replaced.

To change the belts, the belt guard must be removed. The belt tensioner bolt and gearbox mounting bolts must be loosened, and the

gearbox pushed back towards the chipper box. Then the belts can simply be slightly turned and slipped off the rear rotor pulley. During inspection, the belts must be checked for overall wear and deep wear spots from jams. If the belts are worn, they must be replaced with the belt specified on the chipper information plate.

To replace the belts, place the first belt over the rear pulley, pull it tight, then start the belt on the front pulley. Use the same method to move the first belt up to the second pulley groove, then put the second belt on using the same method as the first. Complete the installation by simultaneously pushing and turning the belt onto the pulley.

Belt Tension Procedure

Belt tension is important for the 4003 chipper to operate properly. If the belt tension is too loose, the belt may slip causing excessive belt wear, and if the belt is too tight, rotor RPM, may not reach the correct speed. The correct belt for the 4003 chipper is specified on the information plate on the chipper. Gates "Predator" belts are the correct OEM supplied belt, which offers the best life and performance. The belts on the 4003 are a wear item. If needed other Kevlar belts can be used however different manufacturers belts may be slightly larger / thinner, and belt tension will need to be set accordingly.

Check and modify belt tension by completing the following steps:

1. Ensure that the PTO is disengaged or disconnected, and the emergency stop is engaged (if connected).
2. Remove bottom belt cover. This is completed by removing the two wing bolts and pulling the steel belt cover from under the machine.
3. If using a Gates Optibelt tension gauge or other tension gauge the tension should be approximately 60 to 80 lbs of tension on each belt. If you do not have a tension gauge pinch the belt with approximately 60 lbs of force. When doing so each side of the belt

should flex $\frac{1}{2}$ " ($\pm \frac{3}{16}$ ") in or out. This method will work however a tension gauge is recommended for best results.

Note, to verify correct tension with new belts, replace belt cover, and run the 4003 chipper at 540 PTO RPM for 10 mins. Then recheck belt tension. The 10-minute run will break in the belt and will show a more accurate tension.

4. If the belt is not tensioned correctly or the belts need to be replaced, loosen the four gearbox mount bolts. If replacing the belts use the nut on the front of the tensioner bracket (A) to loosen the old belt, if it does not loosen just by unthreading the tensioner nut, push the gearbox back towards the chipper box. To tension the belts tighten the tensioning nut by making small adjustments of approx. $\frac{1}{4}$ turn for best results.

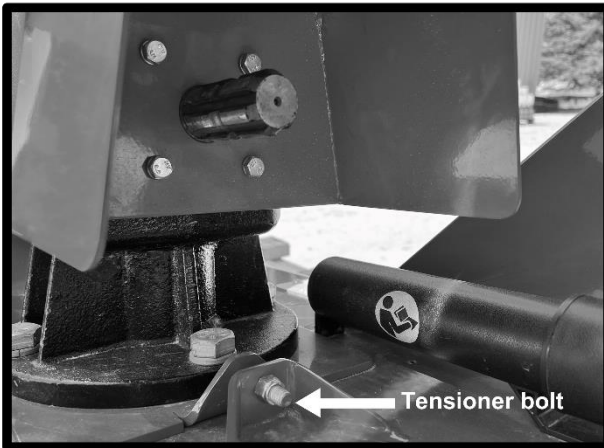

5. After adjusting the tensioner, tighten the four gearbox bolts to 120 ft-lbs and check the belt tension again as described in step 3. If belt is not correctly tensioned repeat steps 4 and 5 until proper tension has been met.

6. Once belt is tensioned correctly, replace the belt cover, disengage the e-stop, and you are ready to begin chipping.

5.18 Latch Maintenance

Your woodchipper is assembled with 4 latches which fasten the infeed chute to the main frame of the woodchipper. It is important that these latches are in good working condition to ensure that the infeed chute is fastened securely at all times. If a latch breaks or becomes faulty do NOT use the machine and replace the defective part immediately.

To adjust the latch tension, turn the 2 nylock nuts up or down equally to increase / decrease latch tension. The correct tension is when it requires approximately 25 lbs of force to close the latch into the locked position. If the latch is excessively difficult, the nylock nuts should be slightly loosened. If the latch requires no force to close, the nuts should be tightened equally to meet the required 25 lbs force required to lock the latch.

5.19 Torque Spec Chart

This spec chart lists all the torque specs for every fastener located on the 4003 woodchipper. It is important that all fasteners be torqued to the correct specification to ensure safe operation. **WARNING – Incorrect torque specs can result in serious injury or death!!!**

Description	Type	Quantity	Torque Spec
Blade(s)	7/16" x 1" Flat	4 (8)	35 ft-lbs. w/ anti-seize
Anvil Blade	7/16" x 1"	4	50 ft-lbs.
Top Cap Bolts	1/2" x 1	12	60 ft-lbs.
Top Bearing Bolts	5/8" x 1 1/2"	2	80 ft-lbs.
Bottom Bearing Bolts	5/8" x 1 1/2"	4	80 ft-lbs.
Chipper Box Bolts	1/2" x 3/4"	8	60 ft-lbs.
Gearbox Bolts	3/4" UNF x 2"	4	120 ft-lbs.
PTO Guard Bolts	M8 x 15mm	4	21 ft-lbs.

6. Storing Your Woodchipper

When storing your woodchipper special attention should be drawn to the areas below. Storage steps depend on duration which can be found below.

1-4 Weeks Storage

1. Clean your machine as listed in the “after operation” section.
2. Store the woodchipper in a dry, clean, and secure area.

It is not uncommon for Split-Fire products to be stolen due to their value and ease of mobility. Always store your machine in a secure area.

5+ Weeks Storage

1. Clean your machine as listed in the “after operation” section.
2. Remove the infeed chute and spray a light oil mist on paintless areas such as the rotor, top cap, latches, and infeed chute. This will prevent any surface rust during long term storage. (This oil must be washed off with biodegradable solvent when the machine is placed back into service).
3. Store the woodchipper in a dry, clean, and secure area. If the machine is to be stored outside, tightly wrap the machine in a tarp to reduce moisture and UV exposure.

It is not uncommon for Split-Fire products to be stolen due to their value and ease of mobility. Always store your machine in a secure area.

7. Checklists

Pre-Chip Checklist

By skipping one or any of these instructions greatly increases the chance of personnel injury or death. It is highly recommended to follow this procedure before each use of the woodchipper.

Is the machine on a level and stable surface?

Are all guards in place and in good condition?

Are all safety decals in place and legible?

Is the Infeed hopper in the correct position and securely latched?

Is the cutting chamber clear of debris and foreign objects?

Verify the rotor is in good condition and spinning freely?

Is the chip exhaust deflector mounted and positioned correctly?

Inspect pulleys and belts for wear and damage?

Verify the gearbox is tight and there are no fluid leaks?

Wearing fitted clothing and no jewelry?

Wearing eye protection or a full-face shield?

Wearing hearing protection?

Wearing hand and foot protection?

Do you have a partner in the area to work with for safety?

Does someone know your work plans in case of emergency?

Verify the machine, is it up to date on maintenance?

Safe Feeding Checklist

Materials must be fed into the chipper safely to avoid injury to the operator and to ensure long woodchipper lifecycle. Follow these feeding procedures to keep yourself and other operators safe.

Feed material only when the chipper is at full operating speed.

Feed material from either side of the machine. This will reduce the risk of injury and will also make it easier to feed material while having good access to the emergency stop switch.

Keep hands and feet outside of infeed chute at all times.

Use a push stick to help feed small branches and brush. This will keep operators safe by keeping them away from the moving parts. Do not push materials into the chute with shovels, pitch forks, tools, etc.

Let go of material as soon it begins feeding into the woodchipper. Do not hold onto material to avoid being hit or dragged into the woodchipper.

Feed the branches butt end first. This will help the chipper feed material smoothly and will reduce jams and material kickbacks.



*Never feed material with any part of your body.
Always use a push stick.*



*Shut off the machine and wait for all the parts to stop
Moving before servicing equipment.*

Machine Operator Safety Instructions

1. Each person that operates this Split-Fire log splitter must read and understand this checklist and the rest of the owner's manual before operation.
2. Always wear ear, eye, hand, and foot protection when operating the woodchipper. Never wear loose clothing.
3. Before operating machine, check that all guards and deflectors, pins and locking pins are in place and are in a good working condition, and all the nuts and bolts are properly tightened.
4. Do not operate this equipment in the vicinity of bystanders. Do not allow children to operate this equipment.
5. Do not transport this machine while the PTO is engaged.
6. Body parts must never enter the in-feed or the exhaust chute. Use a long branch or stick to push in small material.
7. This machine is designed to chip wood and brush only! Stones, metal, gravel, and other foreign objects will cause damage to this machine and increase the possibility of personnel injury.
8. If the machine becomes clogged or before a routine inspection, disengage the PTO, disconnect the PTO shaft and make sure the machine has come to a complete stop. Then cleaning and servicing can take place safely.

Checklist

9. Keep the area around the equipment clear of any debris or large accumulations of material in order to have a solid footing and a sure balance.
10. Do not allow processed material to build up around discharge area. Blow chips away from the machine to prevent clogging or fire hazard.
11. When foreign materials of any type enter the chipper, or when the equipment starts to vibrate, it must be immediately shut off and inspected. Then replace, repair, or tighten any parts where needed.
12. Carbon monoxide can be extremely dangerous in enclosed areas. Do not run equipment in enclosed areas as the exhaust from the engine contains carbon monoxide.
13. Operate machine on a level surface only. Do not operate on a paved or gravel surface.
14. Failure to comply with these guidelines may cause serious injury or death.

Note!

Read and understand your tractor's owner's manual for safe and dependable engine operation before using this equipment.

I have read and fully understand all of the above.

Customer/Operator Signature: _____

Date: _____ / _____ / 20_____

Parts Breakdown

Parts Breakdown

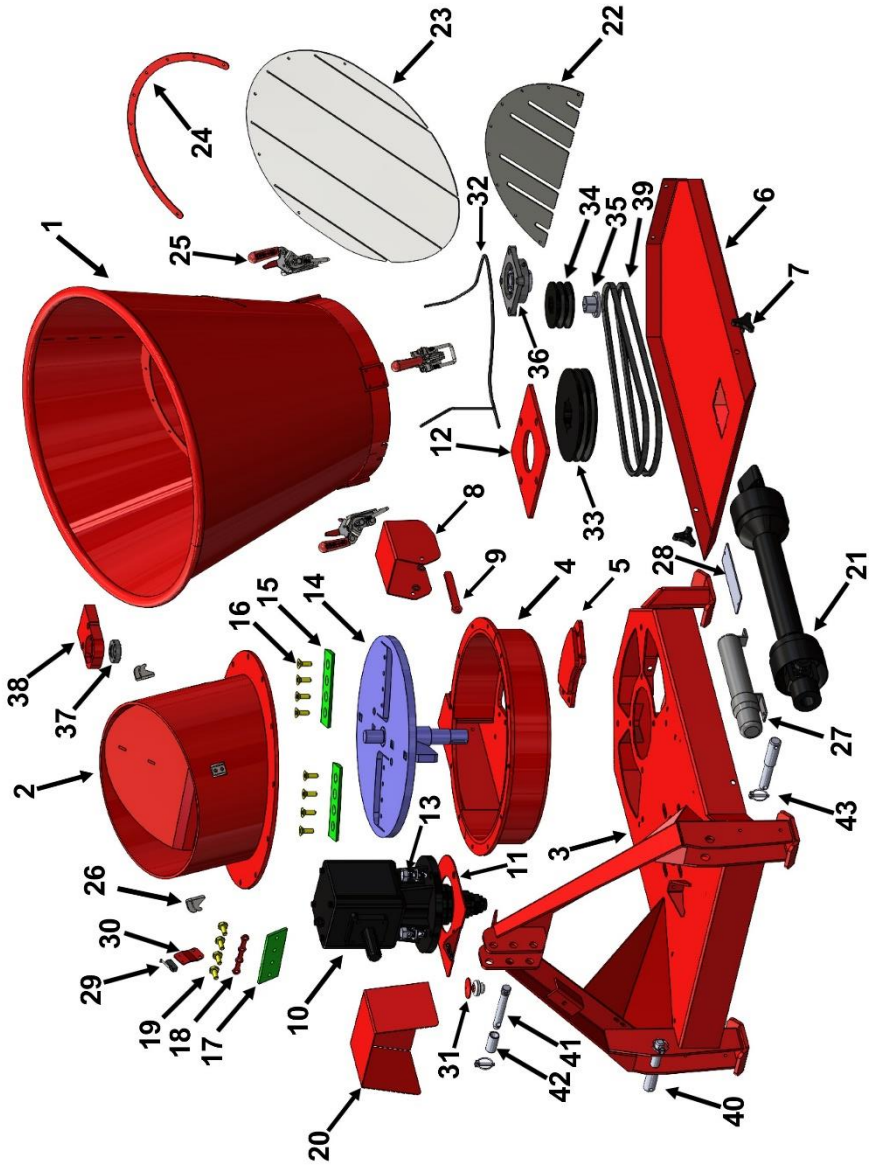

Item	Part Number	Description	
1	SWP-IC49	Infeed Chute	Kick Back Flap Brace
2	SWP-TC49	Main Frame Top Cap	Kick Back Flap Upper
3	SWP-MF40	Main Frame	Kick Back Washer
4	SWP-RB40	Main Frame Chipper Box	Infeed Latch
5	SWP-RBC	Main Frame Chipper Box Cleanout	Infeed Latch Catch
6	SWP-BG41	Belt Guard	Manual Cannister
7	SWP-WB	Wing Bolt	Specification / Serial # Plate
8	SWP-OD49	Outfeed Deflector	Infeed Chute Switch
9	SWP-OH49	Outfeed Deflector Handle	Infeed Chute Switch Bracket
10	SWP-GB40	Gearbox	E-Stop Button
11	SWP-BT40	Gearbox Belt Tensioner	E-Stop Circuit
12	SWP-BP40	Gearbox Bolt Plate	Primary Sheave / Pulley
13	SWP-GBB34FT	Gearbox Bolt - 3/4"-16 X 2" (Fine Thread) w/ Lock Washer	Secondary Sheave / Pulley
14	SWP-R2B49	Rotor	Secondary Sheave Bushing
15	SWP-CB	Blade - 2 x (7-1/4" x 2-3/4" x .421)	Four Bolt Lower Flange Bearing
16	SWP-BB716C	Blade Bolts - 8 x (7/16"-20 x 1-1/4" Flat Head)	Upper Sealed Bearing
17	SWP-BB	Bed Blade / Anvil	Upper Bearing Housing
18	SWP-BBW716	Bed Blade Washer	Upper Bearing Housing
19	SWP-BBB716F	Bed Blade Bolts - 4 x (7/16"-24 x 1")	Kevlar V-Belt - (Refer to Info Plate)
20	SWP-PC40	PTO Shaft Guard	Lower 3 Point Hitch Pin
21	SWP-PTS	PTO Shaft	Upper 3 Point Hitch Pin
22	SWP-KBSS		Upper Pin Cat. 2 Bushing
23	SWP-KBPC		Lynch Pin
24	SWP-KBW		
25	SWP-ILA		
26	SWP-ILC		
27	SLP-PMC-U		
28	SLP-PID-U		
29	SWP-ICSA		
30	SWP-ICSB		
31	SWP-ESB		
32	SWP-ESC		
33	SWP-PS40		
34	SWP-SS40		
35	SWP-SSB		
36	SWP-4BFB		
37	SWP-UB		
38	SWP-UBH		
39	SWP-KVB3		
40	SWP-LHP		
41	SWP-UHP		
42	SWP-C2B		
43	SWP-LP		